

Customer Care Solutions

NPL-2 Series Cellular Phones

8 – Accessories

Table of Contents

Description	Page No.
Accessories	3
BL-4C, E&A, APAC = Battery, Americas = Li-Ion Battery	3
ACP-7, E&A, APAC = Standard Charger, Americas = Standard Travel Charger	4
ACP-8, E&A = Travel Charger, APAC = Fast & Light Charger	5
ACP-12, Travel Charger	7
LCH-9, E&A, APAC = Mobile Charger	8
LCH-12, E&A, APAC = Mobile Charger	9
HS-5, Headset	10
HDB-4, Boom Headset	11
LPS-4, Inductive Loopset	12
HS-1C, Camera Headset	13
CARK126 +MBC-15S + AXF-15S = Full car kit	14
MBC15S, Mobile Holder	16
AXF-15S, Antenna Coupler	18
HSU-3, Privacy Handset	20
BHF-1, Headrest Handsfree	21
DKU-5, Connectivity Adapter Cable	22
DCV-14, Connectivity Desk Stand	23

Accessories

BL-4C, (E&A, APAC = Battery, Americas = Li-Ion Battery)

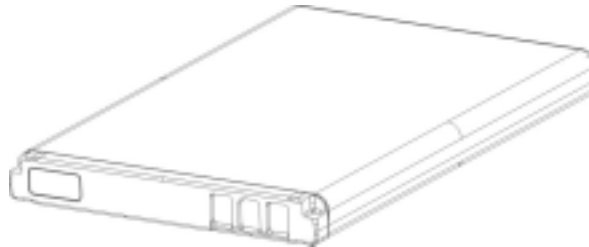

Product details

Features

- Thin and light weight battery

Specifications:

Bulk Codes:	
Eur/Afr & APAC type label	0670386
France type label	0670387
China type label	0670389
Americas type label	0670388
Outbox Codes:	
Eur/Afr	0273560
France	0273561
APAC	027xxxx
Americas	027xxxx
Capacity:	720 mAh
Weight:	18.5 g
Length:	53 mm
Width:	34 mm
Thickness (nominal)	4.6 mm
Thickness (max):	5.0 mm
Nominal voltage:	3.7 V
Operating temperature:	- 10°C to + 40°C
Recommended temperature usage range	+ 15°C to + 25°C
Contact interface:	3 pins golded (Lynx)
Color:	Top caps black Foil color open

**ACP-7, (Eur/Afr & APAC = Standard Charger)
(Americas = Standard Travel Charger)**

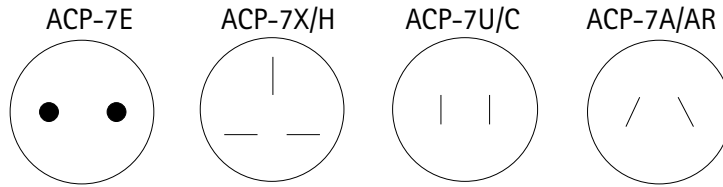
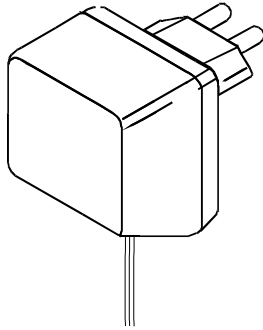

Product details:

Features:

- easy and convenient way to charge the phone
- small, lightweight and durable
- easy to connect to phone or desktop stand

Specifications:

Product code, ACP-7U (Made in country):	0675143
Product code, ACP-7U (Made by "manufacturer"):	0675172
Product code, ACP-7E (Made in country):	0675144
Product code, ACP-7E (Made by "manufacturer"):	0675171
Product code, ACP-7X (Made in country):	0675145
Product code, ACP-7X (Made by "manufacturer"):	0675173
Product code, ACP-7H:	0675146
Product code, ACP-7C:	0675212
Product code, ACP-7C (Philippines ONLY):	0675158
Product code, ACP-7A:	0675148
Product code, ACP-7AR:	0675244
Dimensions (H x W x D):	38 x 47 x 53 mm
Weight:	187 g
Length of cable:	2000 mm ± 10%
Input voltage:ACP-7U (US)	120 V AC, 60 Hz
ACP-7E (Europe) and ACP-7X (UK)	230 V AC, 50 Hz
ACP-7A (Australia)	240 V AC, 50 Hz
ACP-7C (China)	220 V AC, 50 Hz
ACP-7H (Hong Kong)	200 V AC, 50 Hz
ACP-7AR (Argentina)	220 V AC, 50 Hz
Output voltage:	7.6 ± 0.35 V
Charging time:	Refer to battery specifications

**ACP-8, (Eur/Afr = Travel Charger)
 (APAC = Fast & Light Charger)
 (Americas = Rapid Travel)**

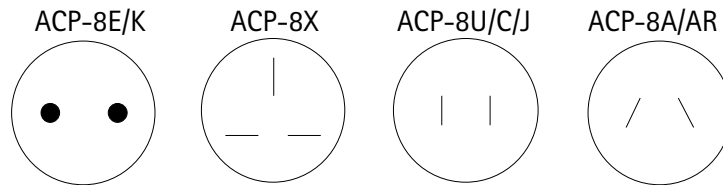
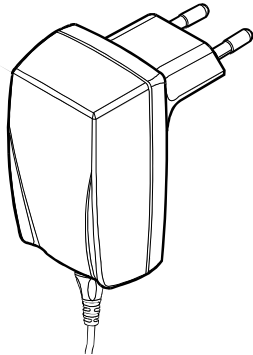

Product details:

USPs:

- beautiful Nokia design
- talk and charge at the same time
- Nokia power management – phone, battery and charger all working together for the best results
- fast and efficient way to charge the phone battery
- multivoltage
- small, lightweight and durable
- easy to connect to phone or desktop stand
- cable management provided with velcro strap
- suitable for active travellers

Specifications:

Product code, ACP-8E:	0675195
Product code, ACP-8U:	0675196
Product code, ACP-8U (Made by "manufacturer"):	0675269
Product code, ACP-8X:	0675197
Product code, ACP-8J:	0675198
Product code, ACP-8K:	0675199
Product code, ACP-8A:	0675214
Product code, ACP-8C:	0675211
Product code, ACP-8UB:	0675236
Product code, ACP-8G:	0675237
Product code, ACP-8AR:	0675248

Dimensions, ACP-8E/K (H x W x D):	70 x 40 x 73 mm
Dimensions, ACP-8U/C/G/UB (H x W x D):	70 x 40 x 56 mm
Dimensions, ACP-8X (H x W x D):	72 x 50 x 64 mm
Dimensions, ACP-8A/AR (H x W x D):	74 x 43 x 61 mm
Weight:	75 + 35 (cable) g
Length of cable:	1800 mm ± 50 mm
Color:	Warm Black
Input voltage:	90 to 264 V AC, 50/60 Hz
Output voltage:	6.0 +0.3 V / -0.7 V
Charging times:	Refer to battery specifications
Operating temperature:	- 5° ... + 45° C

ACP-12, Travel Charger

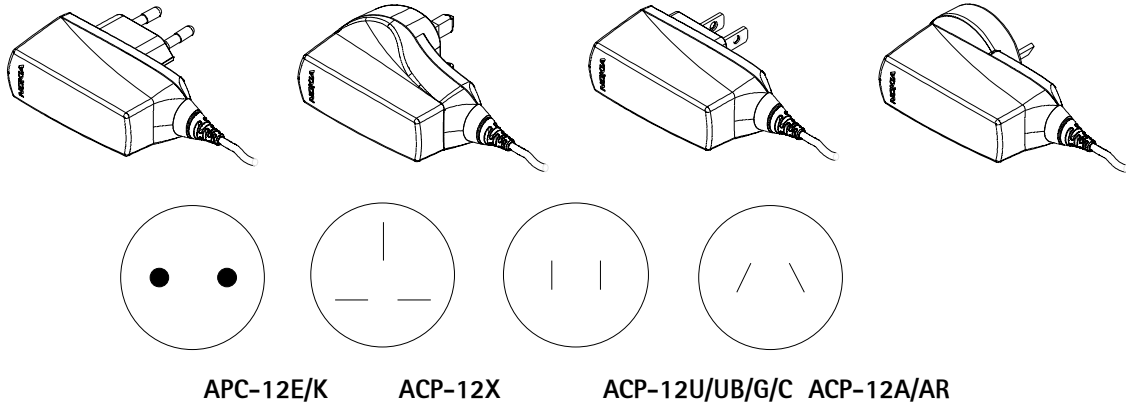

Product details:

Features:

- Small and light weight travel charger
- High performance charger
- Multivoltage (90 –264V)
- Fullfills the long run EU Code of conduct requirement on efficiency
Low standby power consumption < 300mW
- Fixed cable with cable management

Specifications:

Product code, ACP-12E:	0675294
Product code, ACP-12X:	0675296
Product code, ACP-12U:	0675303
Product code, ACP-12UB:	0675293
Product code, ACP-12G:	0675295
Product code, ACP-12C:	0675297
Product code, ACP-12A:	0675300
Product code, ACP-12AR:	0675298
Dimensions (H x W x D):	28x75x70mm (E), 50x75x60 (X)
Weight:	~ 85g
Length of cable:	1800mm +/-50mm
Colour:	Warm black
Cable Management:	Velcro type
Input voltage:	90 - 264V AC 50/60Hz
Output voltage:	5,7VDC, 800mA
Standby power consumption:	<300mW
Operating temperature:	- 25° ... + 55° C

LCH-9, Mobile Charger (Americas = Rapid Cigarette Lighter Charger)

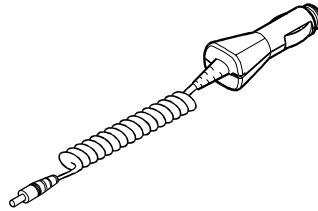

Product details:

Features:

- easy and convenient way to charge the phone battery in a vehicle
- suitable for most vehicle's cigarette lighter socket
- a green light indicates readiness for charging
- light weight and small size - unobtrusive when plugged into the cigarette lighter socket wherever the socket is located
- easy to connect the DC cable/connector to the phone
- can be used with 12 V or 24 V systems

Specifications:

Product code (English type label):	0675120
Product code (Chinese type label):	0675239
Dimensions (H x W x D):	29 x 35 x 94 mm
Weight:	97 g
Length of cable:	Coiled 0.3 m \pm 10% (Uncoiled 3 m \pm 10%)
Input voltage:	10.8 to 32 V DC
Output voltage:	7.8 \pm 1 V
Charging time:	Refer to battery specifications

LCH-12

TBD

Product details:

Features:

- High performance charger
- Easy and convenient way to charge the phone battery in a vehicle
- A green light indicates readiness for charging
- Can be used with 12 VDC or 24 VDC systems
- Light weight and small size - unobtrusive when plugged into the cigarette lighter socket wherever the socket is located

Specifications:

Product code LCH-12:	0675328
Dimensions (H x W x D):	26 x 34 x 98 mm TBD
Weight:	< 100 g
Length of cable:	Uncoiled 160 cm ± 10% (Coiled TBD cm ± 10%)
Input voltage:	10.8 to 32 V DC
Color	Jet Black
Nominal output voltage, current:	5.7 VDC, 800mA
Operating temperature:	-25°C ... +55°C (normal temperature range in which the charger must fulfill all the specifications)

HS-5, Headset



Product details:

USPs/Features:

- Basic headset with good audio quality
- Send/End button for convenient usage
- Low cost

Specifications:

Product code (Eur/Afr and APAC type label):	0694120, 0694121 & 0694122
Dimensions (H x W x D):	72 x 48 x 17mm
Weight:	20 g
Length of cable:	1350 +/- 30 mm (Earpiece to Connector)
Connector Type:	Pop-Port
Earpiece Size:	16.5mm (max. speaker capsule diameter)
Colour:	Black
Operating temperature:	- 25° ... + 55° C

HDB-4, Boom Headset

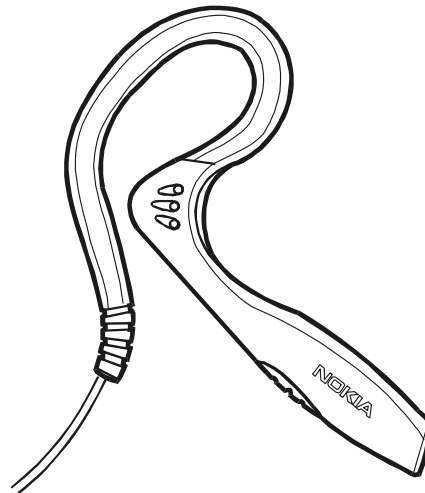

Product details:

USPs:

- basic HF functionality with send/end button
- new concept
- beautiful and distinctive Nokia design
- small and lightweight
- excellent audio quality

Features:

- basic HF functionality with send/end button
- new concept
- Microphone and speaker integrated to the boom

Specifications:

Product code:	0694094
Product code (Chinese label):	0694108
Color:	Black
Weight:	20g
Length of cable:	970 +/- 25 mm
Connector:	Tomahawk
Operating temperature:	-20° C ... + 60° C

LPS-4, Inductive Loopset



Product details:

USPs:

- Mobile freedom for hearing aid users
- Handsfree operation without batteries

Features:

- No batteries needed
- ACI = Loopset detection
- Cochlear Implant connector support
- Excellent audio quality
- Audio input (connection to external devices e.g. tv,video etc.)

Specifications:

Product code (Eur/Afr and APAC type label):	0630443
Product code (Chinese type label):	06XXXXX ?
Product code (Americas type label):	06XXXXX ?
Dimensions (H x W x D):	17 x 40 x 55 mm
Weight:	48 g
Length of cable:	mm ?
Color:	dark platinum 2
Charging times:	No batteries needed
Operating temperature:	- 20° ... + 55° C

HS-1C, Camera Headset**TBD****Product details:****USPs:**

- Combination of digital Camera and Headset
- Basic Handsfree functionality with answer/end button
- Small and lightweight
- Stylish and trendy Nokia design
- Excellent wearability

Features:

- Single shot camera – VGA and low resolution selection
- Pop Port connection – power from phone
- LED for indicating operating mode of the camera
- Optical viewfinder
- Photos are displayed on phone display
- Store, delete, send etc. commands from the phone
- Dual mono headset
- Answer/end button in headset part
- Microphone integrated into the camera unit

Specifications:

Product code (Eur/Afr and APAC type label):	0694XXX
Product code (Chinese label)	0694XXX
Weight:	XX g
Dimension:	XX
Length of cable:	XX mm
Color:	Light champagne
Connector:	Pop Port
Resolution:	VGA 640x480
	Low resolution 128x96
Color depth:	24 bit
Light sensitivity:	10 Lux
Operating temperature:	XX

CARK126 + MBC-15S + AXF-15S = Full Car Kit



Product details:

USPs:

- Convenient handsfree usage
- Connection to an external antenna
- Provides charging of the phone and car radio mute
- Phone voice dialling features (phone specific!) are accessible via car kit
- Privacy and data possibility

Marketing Names:

- Eur/Afr & APAC Full Car kit Consists of Cark 126 + MBC-15S & HHS-15 AXF-15S
- Americas Full Car kit (?) Different packaging strategy!!!!

NOTE Full Car Kit as such NOT AVAILABLE, but consists of separately sold Car Installation Kit, Cark126, separately sold Mobile Holder, MBC-15S & HHS-15 and separately sold Antenna Coupler , AXF-15S.

Features:

- Handsfree audio
- Secure location for the phone via separately sold MBC-15S mobile holder
- Privacy handset HSU-3 (optional, only in Eur/Afr), data via separate data cable
- External antenna connectivity via separately sold Antenna coupler AXF-15S
- Charging
- Car radio mute
- Ignition sense
- Noise - and echo cancellation

Specifications:

Product code (Eur/Afr and APAC type label):	See separate sales package below
Input voltage:	10.8-16V DC
Current consumption:	max 2A DC (?)
Speaker ourput	3W max (?)
Length of power cable:	4000mm
Color:	Main color black

Car Installation Kit CARK126

Item	NMP Type	NMP Code	Remarks
Sales Package Code Eur/Afr APAC	CARK126	0085197	
Handsfree Unit	HFU-4	0694103	
Mounting Plate	MKU-1	0620036	Includes screws and Nokia logo plate
Microphone	HFM-8	0690016	
External HF Speaker	HFS-12	0692009	
System cable	SCU-4	0630471	
Power cable	PCU-4	0630478	4 Pin connector cable
Installation guide		027xxxx	
Carton box		965xxxx	
Box sticker		9380107	
Master Carton		9651336(?)	There is 10 pcs of Cark126 0085197 in one Master 9651336

MBC-15S, Mobile holder

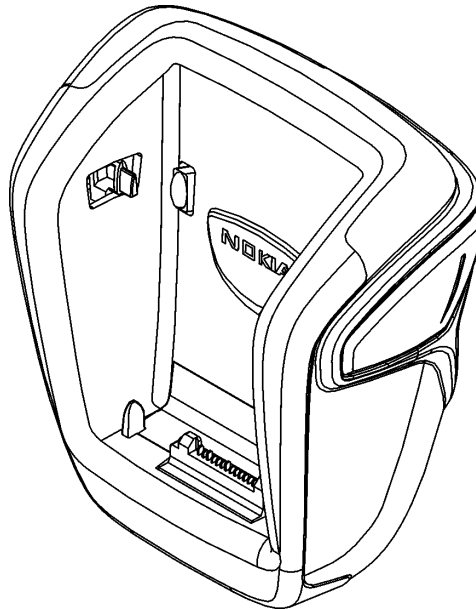

Product details:

USPs:

- Secure place to hold the phone in the vehicle
- Supports external antenna connectivity via separately sold & installable AXF-15S Antenna coupler (coupler installed on top of the holder and locked between MBC-15S and swivel HHS-15)
- Strong Nokia design
- Convenient to use (easy insertion/removal of phone)
- Fulfills car manufacturer requirements ECE16/21R

Features:

- Enables the Basic HF (BHF-1) and CarK126 (car Installation Kit) use with NPL-2
- Enables usage of CLC and/or headset
- Easy to attach to the dashboard with swivel, HHS-15 or mounting plate, MKU-1
- Ergonomically designed release buttons
- Phone specific size

Specifications:

Idea:	Safe place to keep the phone in the car
Platforms:	Small size tomahawk bottom connector phones
Use enviroments:	Vehicle
Overview (main parts):	A- and B-covers, release buttons on both sides
Drivers (in order):	Cost, car safety (SPR requirements apply), design in line with MBC-13L
Main functions (in order):	Hold phone firmly in place
Weight:	Tbd (<=MBC-14M)
Dimensions:	(H x W x D) tbd (<=MBC-14M)
Colour:	A-cover: B-cover: release buttons: Standard black GE 76701
Material:	Covers: ABS/PC plastic Buttons: plastic
Label:	Type label size: 32 x 11 mm Type label material: Metalized polyester film "Brady" Type label content: <ul style="list-style-type: none"> • "Made in Finland" • bar code • 18 digit code
Features:	Connector back of the holder provides support of car kits (BHF-1, Cark126) as well as separately usage of headset and CLC charger. Data support via same connector in cradle possible.
	Nokia logo in A-cover rubber plate.
	Uses swivel HHS-15.
	Same kind of insertion and removal as in MBC-13L/14M
	Release buttons must work the same way as MBC-13L/14M
	It has to be easy to fit the phone in the holder as well as to remove it

Mobile Holder

Item	NMP Type	NMP Code	Remarks
Sales Package code for Eur/Afr & APAC		0273724	
Mobile holder (for small -size phones)	MBC-15S	0650041	Holder supporting charging (and external antenna via coupler)
Swivel Mount	HHS-15	0620060	
Artcard			
Clamshell		9675690	
5-pack Carton box		9651421	
Box sticker		9380107	
Master Carton		9650003	

AXF-15S Antenna Coupler

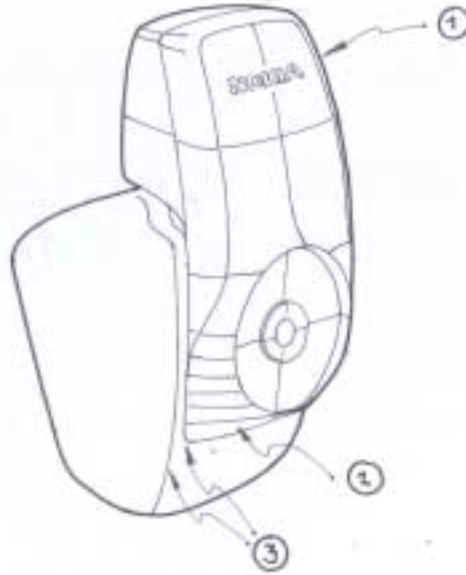

Product details:

USPs:

- Universal Antenna Coupler
- Stylish Nokia design - complementing the phone holder, MBC-15S, design
- Secure installation on top of holder and fastened between holder and swivel
- Small size
- Provides connectivity to an external antenna, via FME connector at the end of Antenna Coupler cable. (Phone has to be properly inserted in mobile holder and Antenna Coupler correctly installed.)

Features:

- Universal Coupler supports use with Headrest HF, BHF-1), Car Installation kit (Cark126) and headset.
- Usage possible in combination with mobile holder, MBC-15S and Swivel HHS-15 only.

Specifications:

Product code :	075018
Dimensions (H x W x D):	? x ? x ? mm
Weight:	? g
Type label size:	23,8 x 17,5 mm (same size as AAK-1/AAE-1)
Colour:	Standard Black
Material:	ABS/PC Plastic
Nokia logo:	In B-cover mold backside of Antenna Coupler
Miscellaneous:	
Operating temperature:	- 25° ... + 55° C

Antenna Coupler

Item	NMP Type	NMP Code	Remarks
Sales Package code for Eur/Afr & APAC		0273723	
RF Coupler (for small -size phones)	AXF-15S	0750189	
Artcard			
Clamshell			
5-pack Carton box		965xxxx	
Box sticker		9380107	
Installation guide			Needed???
Master Carton		9650003(?)	

HSU-3 Privacy Handset



Product details:

Features:

- Easy and intuitive one hand motion to insert or remove the handset from the handset holder
- "privacy" handset can be installed separately for convenient and courtesy use
- (bottom of cradle consists of removable installation plate)
- Automatic switch over to "private" mode when handset is lifted from the cradle
- Smooth and ergonomic NOKIA design providing optimal ease of use features as handset
- Easy installation via removable installation plate in bottom of handset cradle.
- Switching back from privacy mode to HF mode possible (see phones user guide)
- Volume control (audio level adjustment)
- Light guide on top of handset release button

Specifications:

Product code, HSU-3 (English type label):	0650039
Dimensions:	
Handset (L x W):	mm
Cradle (L x W):	mm
Combined height:	mm
Color:	Standard black

BHF-1 Headrest Handsfree



Product details:

USPs:

- Excellent audio quality
- Easy to install
- Basic handsfree functionalities
- Easy to use
- Ergonomic and distinctive Nokia design

Features:

- Integrated microphone and speaker
- Installation in car's headrest
- Safe handsfree functionality in car environment

Specifications:

Product code (Eur/Afr and APAC type label):	0694102
Dimensions (L x W x H):	250mm x 40mm x 40mm (main body), 15mm x 200mm (flexible arm)
Weight:	300 g
Length of cable:	3 m
Colour:	Black, Palladium (silver)
Operating temperature:	- 25° C ... + 55° C

DKU-5 Connectivity Adapter Cable



Product details:

USPs:

- Seamless connectivity between USB compatible PC and Nokia phone. Supports Nokia PC Suite usage and synchronization desk stand.
- Enables data transfer and synchronization with PC (calendar, phone book, notes, to do list, etc. depending on PC Suite features)
- Fast data rate 230kbits/s supported

Features:

- FBUS/USB adapter cable for phone without USB support
- USB connectivity to PC
- Supporting fast data rate up to 230kbits/s (Fast FBUS data rate 230kbits/s supported - 115.2kbits/s default on phone side)
- Accessory identification - ACI function

Specifications:

Product code:	0730235
Sales package code (Eur/Afr):	0273436
Type Label Size:	13x10 mm (USB)
Dimensions (H x W x D):	-
Weight:	44 g
Length of cable:	1200 mm
Colour:	Black
Material:	Halogen free PVC
Operating temperature:	- 35° ... + 80° C

DCV-14 Connectivity Desk Stand

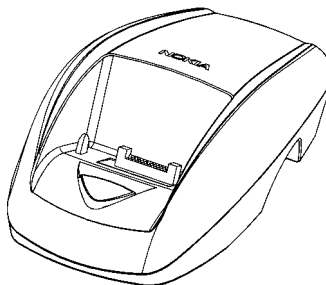

Product details:

USPs:

- Supports the cellular phone in an upright position for an easy and convenient way to charge or keep the phone.
- Possibility to use the desk stand with headset. You can listen to phone's radio or answer incoming calls while charging the phone in the desk stand.
- Phone can be synchronised with PC (calendar, phone book, notes, to do list, etc.) using USB cable.

Features:

- 1-slot desk stand
- Connects easily to Travel Chargers ACP-7, ACP-8, ACP-9 and ACP-12
- Connectivity cable / Headset connector
- Synchronisation Button. Starts data transfer with compatible PC organiser software (requires computer connection and PC software supplied with phone)

Specifications:

Product code (Eur/Afr and APAC type label):	0675323
Product code (Chinese type label):	06XXXXX
Product code (Americas type label):	06XXXXX
Type label size:	23,8 x 17,5 mm
Dimensions (H x W x D):	106 x 70 x 40 mm
Weight:	140 g (target)
Color:	A-cover Grey, B-cover Black
Charging times:	Refer to battery specifications
Operating temperature:	- 5° ... + 55° C

This page intentionally left blank